



Signal Forge 2500M™  
Frequency Expansion Module

1.5 GHz to 2.6 GHz

# User Manual





# ***Technical Support***

Email: [Support@signalforge.com](mailto:Support@signalforge.com)

Phone: 512.275.3733 x2

# ***Contact Information***

Web: [www.signalforge.com](http://www.signalforge.com)

Sales and Customer Service Email: [Sales@signalforge.com](mailto:Sales@signalforge.com)

Phone: 512.275.3733 x1

Fax: 512.275.3735

Address: Signal Forge, LLC ▪ 2115 Saratoga Drive ▪ Austin TX 78733

---

## Table of Contents

<b>INTRODUCTION</b> -----	<b>1</b>
General Features-----	1
Applications-----	2
<b>SPECIFICATIONS</b> -----	<b>3</b>
<b>CONNECTIONS</b> -----	<b>4</b>
2500M Front Panel-----	4
Rear Panel-----	5
<b>CONNECTING THE 2500M</b> -----	<b>6</b>
<b>OPERATING THE 2500M</b> -----	<b>7</b>
Menu Control-----	7
External FSK Control-----	11
<b>WAVEFORMS</b> -----	<b>8</b>
Chirp-----	8
Pulsed Chirp (Pulsed FM)-----	8
FSK Arbitrary Waveform-----	9
FSK Ramped-----	10
FSK Triangle-----	10
FSK Unramped-----	11
Single Tone-----	12
<b>OPERATING LIMITS</b> -----	<b>13</b>
Operating Ranges-----	13
<b>CALIBRATION</b> -----	<b>14</b>
<b>GENERAL SAFETY AND WARRANTY</b>	
<b>INFORMATION</b> -----	<b>15</b>
To Avoid Fire or Personal Injury-----	15
Warranty-----	15

---

## Table of Figures

Figure 1. 2500M Front Panel -----	4
Figure 2. 2500M Output Driver Circuit -----	4
Figure 3. 2500M Rear Panel-----	5
Figure 5. Main Menu of the Wave Manager software. -----	7
Figure 6. External FSK Control Operation	12
Figure 7. Pulsed Chirp Operation -----	9
Figure 8. Example FSK Arbitrary Waveform	9
Figure 9. Sample - FSK Arbitrary Text File	10
Figure 10. FSK Ramped Modulation -----	10
Figure 11. FSK Triangle Modulation-----	11
Figure 12. FSK Unramped Modulation-----	11

## Table of Tables

Table 1 Operating Ranges -----	13
--------------------------------	----

---

## ***Introduction***

The Signal Forge 2500M Frequency Expansion Module is a frequency multiplier source that attaches to the Signal Forge 1000 Signal Generator and generates an RF (AC-coupled) output in the frequency band of 1.5 GHz to 2.6 GHz. Two models are available, the 2500M with output power range -21 dBm to +9 dBm and 2500M HP with output power range -13 dBm to +16 dBm.

### ***General Features***

- RF output: 1.5 GHz to 2.6 GHz
- Output power range of -21 dBm to +9 dBm (HP model -13 dBm to +16 dBm)
- 1 Hz resolution
- Low close-in phase noise
- Excellent stability
- High frequency accuracy
- Frequency sweep
- FSK modulation (internally and externally controlled)
- Chirp
- Connects to and is controlled by the Signal Forge 1000 and 1000E Signal Generators

## *Applications*

- Programmable RF or CW source
- Local Oscillator (L.O.) source
- Test microwave amplifiers for gain and the 1 dB compression point
- Testing filter BW using sweep mode
- FM receiver testing using FSK and frequency sweep
- RF exciter
- Programmable clock generator
- Receiver calibration

## Specifications

Frequency Range.....	1.5 GHz to 2.6 GHz
Frequency Resolution.....	1 Hz
Frequency Accuracy .....	.01 ppm
Amplitude Range.....	64 mV to 800 mV
Amplitude Resolution.....	1 dB
Power Range.....	2500M -21dBm to +9 dBm 2500M HP -13 dBm to +16 dBm
Power Output Accuracy.....	±2 dB over full frequency and power range
Phase Noise	-84 dBc/Hz @ 1 KHz Offset -92 dBc/Hz @ 10 KHz -110 dBc/Hz @ 100 KHz
Harmonics-.....	< -30 dBc
Non-Harmonics.....	-80 dBc
Spurious.....	-80 dBc
Power Requirements.....	150mA at 15V (sourced from the SF1000 or SF1010)

### Notes

1 – There is a gap between the 1 GHz maximum frequency output of the SF10x0 and the 1.5 GHz frequency range of the 2500M. If you need a frequency within this gap range select the 2000M Expansion Module which provides an RF output in the 1 GHz to 2 GHz frequency band. If you need an RF output in other frequency bands, please contact Signal Forge Tech Support at [support@signalforge.com](mailto:support@signalforge.com) or 512-275-3733 x2.

2 - Output is -40 dBm when the device is first powered up. To prevent leakage, an SMA 50-ohm plug must be attached to the SF2500M SMA output connector.

3 – The SF1000 or SF1010 Portable Signal Generators will drive only **one** output at a time—either the RF output of the 2500M module or one of the internal outputs of the SF10x0 (RF, Digital or Differential).



# Connections

## 2500M Front Panel

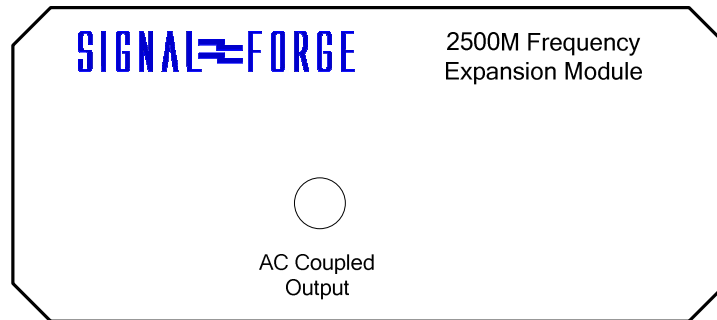

Figure 1. 2500M Front Panel

**RF (AC Coupled) Output.** SMA connector for the AC-coupled output with a frequency range of 1.5 GHz to 2.6 GHz.

The output driver of the 2500M provides a nominal 50-Ohm output impedance. The output driver implementation is described in the drawing below:

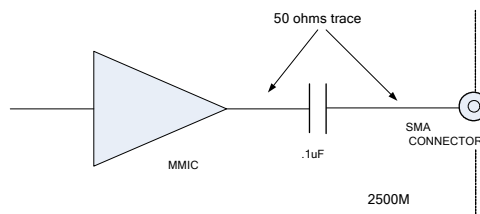

Figure 2. 2500M Output Driver Circuit

**Rear Panel**

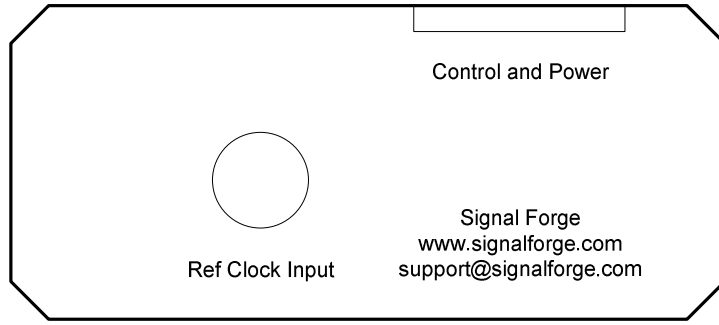

Figure 3. 2500M Rear Panel

**Reference Clock Input.** BNC connector, attaches to the Digital output of an SF10x0 Signal Generator.

**Control and Power.** A ribbon cable attaches to the External Control connector (20-pin ribbon cable) on the front panel of the SF10x0 and provides power as well as control signals.

## Connecting the 2500M

The 2500M connects to the BNC connector on the front of your Signal Forge 1000 signal generator as shown in the drawing below.

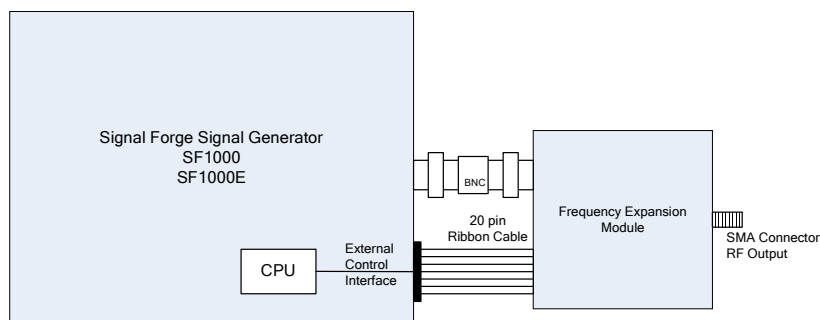

Figure 4. Connecting the 2500M to the Signal Forge 1000 Signal Generator

The following two connections must be made between the Signal Generator and the 2500M:

1. A BNC to BNC straight plug-plug adapter (provided) connects the *Digital Output* of the Signal Generator to the BNC connector on the rear of the 2500M. Replacements for the BNC adapter may be purchased from Digi-Key; order part # ARFX1070-ND.
2. The 10-position Control and Power ribbon cable integrated into the 2500M connects to the 10-position *External Control* connector on the front panel of the SF10x0 and provides both power and control to the 2500M.

### Note

If you wish to use the Frequency Expansion Module with an SF800 Signal Generator contact customer service at [sales@signalforge.com](mailto:sales@signalforge.com) or 512-275-3733 x1.

## Operating the 2500M

Setup, configuration and programming is accomplished using the Wave Manager or EZ Wave software provided with the Signal Generators.

Once connected, the SF10x0 automatically detects the attached module, operational status and programming options for the 2500M are display on the screen.

To configure the 2500M, select **G Operate Attached Module** on the main menu.

### Wave Manager Menu Control

Select Option 'G' from the main menu of Wave Manager.

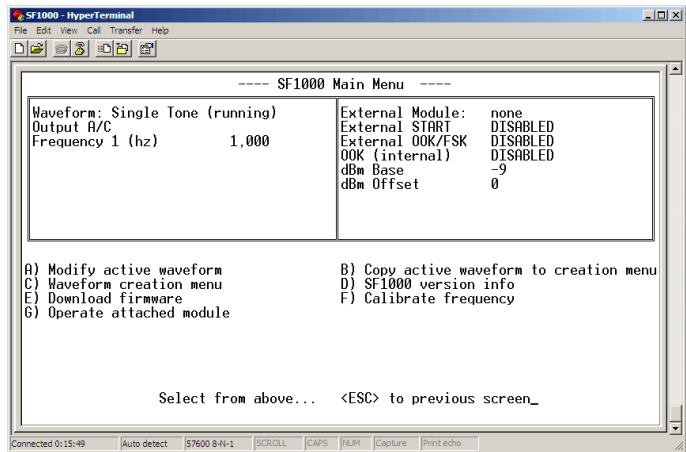

Figure 5. Main Menu of the Wave Manager software.

## **Waveforms**

The 2500M supports the following waveform modulation functions. Numerous waveform modifiers may be applied to customize the output to meet your specific testing needs. The waveforms, modifiers and options are configured using the Wave Manager software.

### **Chirp**

The Chirp waveform ramps the output from frequency 1 to frequency 2 over a specified time, then jumps to the starting frequency to begin the next chirp. A rising or falling chirp is allowed.

The pulse width menu entry specifies the duration of the chirp. The Wave Manager software automatically calculates the delta frequency and ramp rate for the chirp, using up to 50 KHz frequency steps (based on the pulse width and frequency range).

Options

- Externally controlled Start

#### **Chirp Operation for High Frequencies**

Some frequencies are lost close to F1 due to internal hardware limitations.. The amount of lost frequency depends on the rate of change from F1 to F2, the frequency difference between F1 and F2, and the internal lock time.

It is possible to account for lost frequencies near F1 by entering a slightly lower F1 value for a rising chirp or higher F1 value for a falling chirp. It is left up to the user to manually compensate for lost frequencies. The most accurate method is to use a spectrum analyzer to change F1 until the desired range is seen.

### **Pulsed Chirp (Pulsed FM)**

The pulsed-chirp (sometimes referred to as pulsed FM) waveform ramps the output from frequency 1 to frequency 2 over a specified time, jumps to the starting frequency, then idles at frequency 1 until the next chirp. A rising or falling chirp is allowed.

The pulsed-chirp width menu entry specifies the duration of the chirp (frequency 1 to frequency 2). The pulse-to-pulse time menu entry specifies the time between chirps. The Wave Manager software automatically calculates the delta frequency and ramp rate for the chirp, using up to 50 KHz frequency steps (based on the pulse width and frequency range). "Idle time" (the amount of time at frequency 1 between chirps) can be calculated as <pulse-to-pulse> minus <chirp pulse width>.

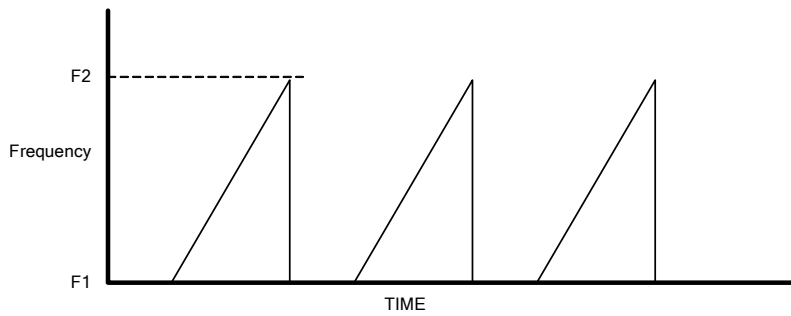

Figure 7. Pulsed Chirp Operation

Options

- Externally controlled Start

As described in the chirp waveform section, the chirp cannot jump immediately back to frequency F1. There will instead be a ramp back to F1. Since there is an idle time at F1, then F1 will be reached so no frequencies are lost.

### FSK Arbitrary Waveform

For FSK Arbitrary Waveforms, a user developed file describing a set of frequency variations is uploaded to the SF10x0 and optionally saved in internal non-volatile memory. One arbitrary data set may be saved at a time.

FSK Arbitrary descriptor files may be created using a text editor or waveform generator software.

Arbitrary FSK allows the user to specify a set of frequency variations, the user-entered data includes:

- Center frequency
- Maximum deviation
- Sample rate
- A set of descriptors that define the deviation for each sample point

The output frequency changes at a time defined by the sample rate. The actual output frequency is determined using the formula

$$F_{out} = \langle \text{center frequency} \rangle + (\text{deviation} * \text{descriptor})$$

Where each descriptor is a floating point value in the range -1.0 to 1.0. For example, a center frequency of 2500 MHz with deviation 10 MHz and descriptor -0.5 will create a frequency of 2495 MHz.

The file format and number of descriptors supported is described in the Creating Arbitrary Waveforms chapter below.

The drawing below illustrates how FSK Arbitrary Waveforms operate.

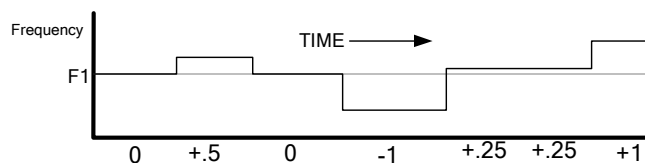

Figure 8. Example FSK Arbitrary Waveform

The FSK waveform shown above was created from the following text file:

```

number_of_points 7
// start with highest output frequency for 1 sample times
1.0
//go down to center frequency and then back to highest using 25% freq X 2
.50 0 -.10 .25 .25 1.0

```

Figure 9. Sample - FSK Arbitrary Text File

## FSK Ramped

The FSK Ramped waveform varies the output frequency within a specified range. The rate of frequency change is determined by the delta frequency (the amount that the frequency is changed at each step) and the ramp rate (at what interval the frequency is changed).

The direction of frequency change is determined by internal timers or by the front panel FSK signal (when external control is enabled). For internal FSK operation, the modulating frequency and duty cycle determine how long frequency1 and frequency2 are selected. When frequency2 is selected, the direction of change is towards frequency2. Once frequency2 is reached, the frequency will remain there until the internal timer signal selects frequency1 (which causes the frequency to ramp towards frequency1).

The user would normally select a modulating frequency and duty cycle such that the ramp has time to complete (i.e. If the FSK signal changes before the ramp is complete, then you will not have reached full range). See drawing below:

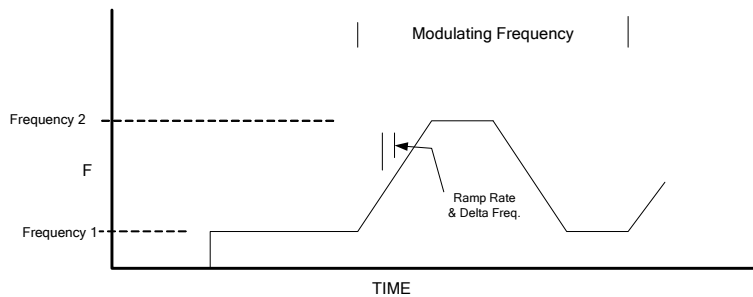

Figure 10. FSK Ramped Modulation

### Options

- Externally controlled Start
- Arbitrary modulation (from a user created file)

## FSK Triangle

FSK Triangle is similar to FSK ramped, except that ramping from one frequency to the next occurs automatically. When an end frequency is reached, the direction changes and ramping continues towards the other frequency. See drawing below:

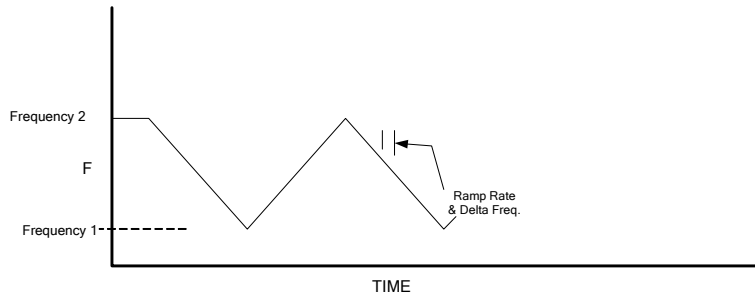

Figure 11. FSK Triangle Modulation

Options

- Externally controlled Start
- Arbitrary modulation (from a user created file)

### FSK Unramped

The Frequency Shift Keying (FSK) Unramped waveform allows you to select two output frequencies which are alternately driven at a preprogrammed rate. For internal FSK operation, the modulating frequency that determines the rate at which the frequencies change is selected from the *Edit Parameters* menu. The duty cycle menu entry determines the duration that frequency1 is asserted versus frequency2. The alternate frequency selection is determined either by internal timers, or by the front panel FSK signal (when external control is enabled).

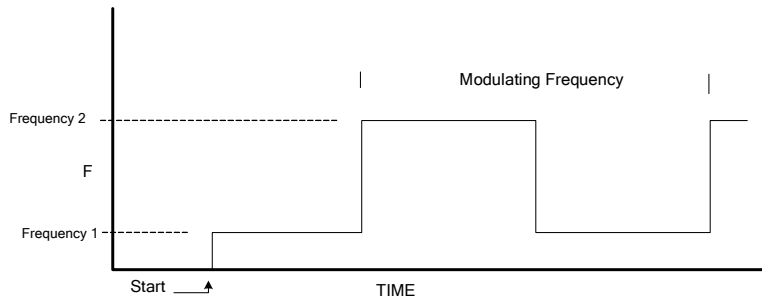

Figure 12. FSK Unramped Modulation

Options

- Externally controlled Start
- Arbitrary modulation (from a user created file)

### External FSK Control

The following figure depicts the way external FSK control operates: the user control source shifts the 2500M output frequency between two preprogrammed values.

For applications, which require external FSK control of the 2500M, the standard Control and Power ribbon cable must be replaced. To order the replacement cable, contact Signal Forge customer service at [sales@signalforge.com](mailto:sales@signalforge.com) or 512-275-3733 x1.



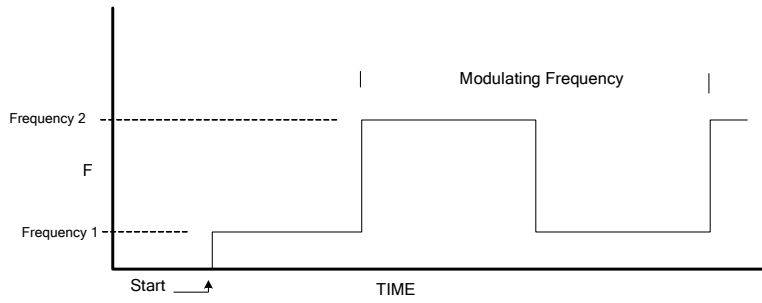

Figure 6. External FSK Control Operation

## Single Tone

The Single Tone waveform outputs a continuous tone at the user-selected output frequency.

Options

- Externally controlled Start

### Note

*External control requires an external user-provided modulating source (TTL level).*



## ***Calibration***

2500M Expansion Module does not require calibration. Its accuracy is dependent on the SF10x0 . Refer to the SF10x0 portable signal generator User Manual for calibration information.

## General Safety and Warranty Information

*Review the following safety precautions to avoid injury and prevent damage to this product or any products connected to it. To avoid potential hazards, use this product only as specified.*

Only qualified service personnel should perform service procedures.

### To Avoid Fire or Personal Injury

**Connect and Disconnect Properly.** Do not connect or disconnect the Control and Power cable to the SF10x0 while the SF10x0 is turned on.

**Observe All Terminal Ratings.** Consult the product manual for ratings information before making connections to the product.

**Do Not Operate Without Cover.** Do not operate this product with the cover removed.

**Do Not Operate With Suspected Failures.** If you suspect there is damage to this product, have it inspected by qualified service personnel.

**Operate Within Operating Range.** Do not operate this product outside the operating ranges specified on the manual.

**Do not operate in Wet/Damp Conditions.**

**Do Not Operate in Explosive Atmosphere.**

**Keep Product Surfaces Clean and Dry.**

### Warranty

Signal Forge warrants that the products that it manufactures and sells will be free from defects in materials and workmanship for a period of one (1) year from the date of shipment. If a product proves defective within the respective period, Signal Forge will repair or replacement the product without charge.

EXCEPT AS PROVIDED HEREIN, SIGNAL FORGE MAKES NO WARRANTY OF ANY KIND, EXPRESS OR IMPLIED, INCLUDING WITHOUT LIMITATION THE IMPLIED WARRANTIES OF MERCHANTABILITY AND FITNESS FOR A PARTICULAR PURPOSE. IN NO EVENT SHALL SIGNAL FORGE BE LIABLE FOR INDIRECT, SPECIAL OR CONSEQUENTIAL DAMAGES.





SIGNAL FORGE, LLC

# ***2500M User Manual v1.05***

---

2115 Saratoga Drive • Austin TX 78733  
Phone 512.275.3733 • Fax 512.275.3735  
[www.signalforge.com](http://www.signalforge.com)

©2009 Signal Forge, LLC. Signal Forge and 2500M are trademarks of Signal Forge, LLC. All rights reserved.

---